

3"-48" DUCTILE IRON MECHANICAL JOINT FITTINGS CLASS 350

BASIC SPECIFICATIONS

- MATERIAL:** Ductile Iron ASTM A536
- PRESSURE:** 350 PSI Water Working Pressure (CLASS 350) 3"-24": 250 PSI 30"-48"
- TESTING:** In accordance with ANSI / AWWA C153 / A21.53
- LAYING LENGTH:** Short body design-straight section of body deleted to provide a compact and lighter fitting without reducing strength or flow characteristics, in accordance with ANSI / AWWA C153 / A21.53 (3"-48")
- CEMENT LINING:** In accordance with ANSI / AWWA C104 / A21.4
- COATING:** Tar coated (bituminous) inside and out in accordance with ANSI / AWWA C104 / A21.4
- GASKETS:** SBR In accordance with ANSI / AWWA C111 / A21.11
- T-BOLTS:** Low alloy corrosion resistant high strength steel in accordance with ANSI / AWWA C111 / A21.11
- STANDARDS:** ANSI / AWWA C153 / A21.53 for Compact Ductile Iron Fittings 3"-24" for water and other liquids.

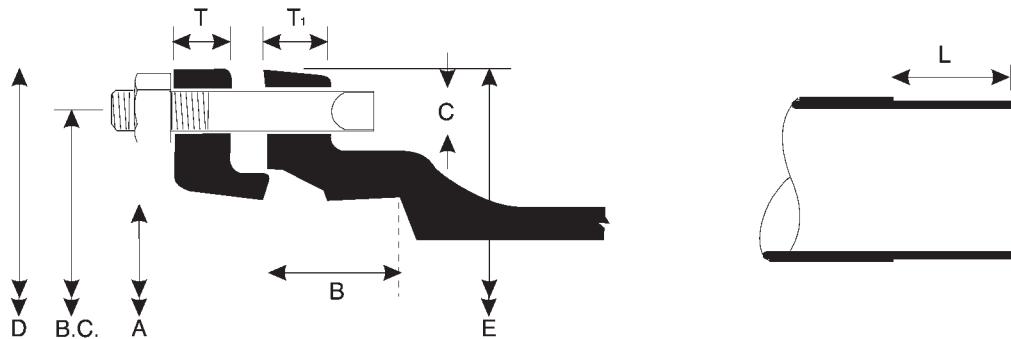

MECHANICAL JOINT DETAILS

PLAIN END DETAILS

Size	A	B	B.C.	C	D	E	T	T ₁	Bolts			Size	O.D.	L
									No.	Size	L			
3	3.96	2.50	6.19	3/4	7.69	7.62	.62	.58	4	5/8	3	3	3.96	5.5
4	4.80	2.50	7.50	7/8	9.12	9.06	.75	.60	4	3/4	3.5	4	4.80	5.5
6	6.90	2.50	9.50	7/8	11.12	11.06	.88	.63	6	3/4	3.5	6	6.90	5.5
8	9.05	2.50	11.75	7/8	13.37	13.31	1.00	.66	6	3/4	4	8	9.05	5.5
10	11.10	2.50	14.00	7/8	15.62	15.62	1.00	.70	8	3/4	4	10	11.10	5.5
12	13.20	2.50	16.25	7/8	17.88	17.88	1.00	.73	8	3/4	4	12	13.20	5.5
14	15.30	3.50	18.75	7/8	20.25	20.25	1.25	.79	10	3/4	4	14	15.30	8.0
16	17.40	3.50	21.00	7/8	22.50	22.50	1.31	.85	12	3/4	4	16	17.40	8.0
18	19.50	3.50	23.25	7/8	24.83	24.75	1.38	1.00	12	3/4	4	18	19.50	8.0
20	21.60	3.50	25.50	7/8	27.00	27.00	1.44	1.02	14	3/4	4	20	21.60	8.0
24	25.80	3.50	30.00	7/8	31.50	31.50	1.56	1.02	16	3/4	4.5	24	25.80	8.0
30	32.00	4.00	36.88	1 1/8	39.12	39.12	2.00	1.54	20	1	6	30	32.00	8.0
36	38.30	4.00	43.75	1 1/8	46.00	46.00	2.00	1.70	24	1	6	36	38.30	8.0
42	44.50	4.00	50.62	1 3/8	53.12	53.12	2.00	1.45	28	1 1/4	6	42	44.50	8.0
48	50.80	4.00	57.50	1 3/8	60.00	60.00	2.00	1.45	32	1 1/4	6	48	50.80	8.0

Weights in pounds
 Dimensions in inches
 All Weights shown without accessories

MJ x MJ

22½° BENDS

MJ x PE

Size	Item No.	Wt.	A	B	T	Item No.	Wt.
3	DIMB322	15	1.00	6.5	.34	DIMP322	12
4	DIMB422	18	1.50	7.0	.35	DIMP422	18
6	DIMB622	31	2.00	7.5	.37	DIMP622	29
8	DIMB822	46	2.50	8.0	.39	DIMP822	43
10	DIMB1022	64	3.00	8.5	.41	DIMP1022	61
12	DIMB1222	80	3.50	9.0	.43	DIMP1222	79
14	DIMB1422	136	3.75	13.0	.51	DIMP1422	133
16	DIMB1622	172	3.75	13.5	.52	DIMP1622	160
18	DIMB1822	255	4.50	14.0	.54	DIMP1822	248
20	DIMB2022	315	4.50	15.0	.57	DIMP2022	290
24	DIMB2422	412	4.50	15.5	.61	DIMP2422	395
30	DIMB3022	665	6.75		.66		
36	DIMB3622	960	7.75		.76		
42	DIMB4222	1350	9.00		.82		
48	DIMB4822	1760	10.00		.90		

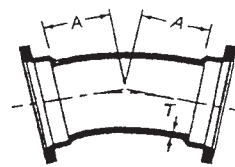

DIMB

MJ x MJ 22½°

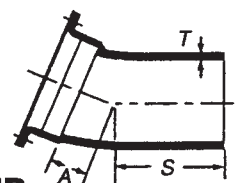

DIMP

MJ x PE 22½°

MJ x MJ

11¼° BENDS

MJ x PE

Size	Item No.	Wt.	A	B	T	Item No.	Wt.
3	DIMB311	14	1.00	6.50	.34	DIMP311	12
4	DIMB411	16	1.25	6.75	.35	DIMP411	17
6	DIMB611	30	1.50	7.00	.37	DIMP611	27
8	DIMB811	42	1.75	7.25	.39	DIMP811	39
10	DIMB1011	58	2.00	7.50	.41	DIMP1011	52
12	DIMB1211	67	2.25	7.75	.43	DIMP1211	69
14	DIMB1411	93	2.50	13.00	.51	DIMP1411	118
16	DIMB1611	148	2.50	13.50	.52	DIMP1611	136
18	DIMB1811	205	3.00	14.00	.54	DIMP1811	248
20	DIMB2011	245	3.00	15.00	.57	DIMP2011	291
24	DIMB2411	315	3.00	15.50	.61	DIMP2411	400
30	DIMB3011	600	4.75		.66		
36	DIMB3611	820	5.00		.76		
42	DIMB4211	1180	6.00		.82		
48	DIMB4811	1475	6.50		.90		

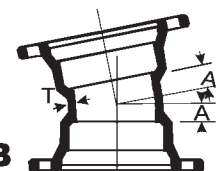

DIMB

MJ x MJ 11¼°

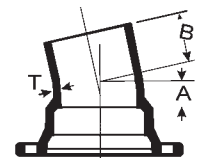

DIMP

MJ x PE 11¼°

Weights in Pounds

Dimensions in Inches

All Weights shown without accessories

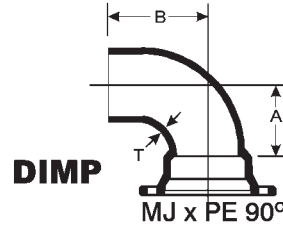
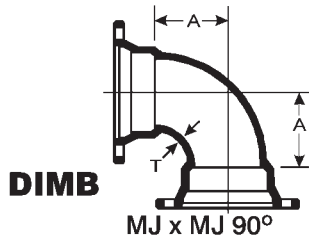

MJ x MJ

90° BENDS

MJ x PE

Size	Item No.	Wt.	A	B	T	Item No.	Wt.
2	DIMB290	17	3.0		.30		
3	DIMB390	19	3.5	9.5	.34	DIMP390	16
4	DIMB490	25	4.0	10.2	.35	DIMP490	22
6	DIMB690	39	5.0	11.7	.37	DIMP690	41
8	DIMB890	57	6.5	12.7	.39	DIMP890	58
10	DIMB1090	89	7.5	14.7	.41	DIMP1090	83
12	DIMB1290	108	9.0	15.7	.43	DIMP1290	114
14	DIMB1490	210	11.5	19.5	.51	DIMP1490	197
16	DIMB1690	264	12.5	20.5	.52	DIMP1690	248
18	DIMB1890	335	14.0	22.0	.54	DIMP1890	311
20	DIMB2090	400	15.0	23.5	.57	DIMP2090	370
24	DIMB2490	565	16.75	26.5	.61	DIMP2490	518
30	DIMB3090	930	25.5		.66		
36	DIMB3690	1450	24.5		.76		
42	DIMB4290	2205	29.25		.82		
48	DIMB4890	2990	33.25		.90		

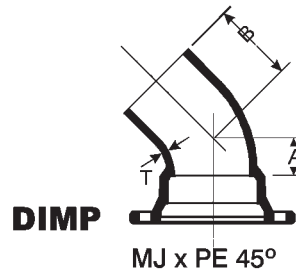
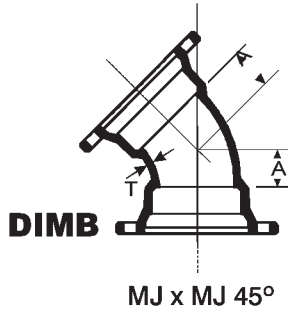

MJ x MJ

45° BENDS

MJ x PE

Size	Item No.	Wt.	A	B	T	Item No.	Wt.
2	DIMB245	10	1.5		.30		
3	DIMB345	16	1.5	7.0	.34	DIMP345	13
4	DIMB445	22	2.0	7.7	.35	DIMP445	19
6	DIMB645	32	3.0	8.7	.37	DIMP645	34
8	DIMB845	46	3.5	9.2	.39	DIMP845	49
10	DIMB1045	73	4.5	10.2	.41	DIMP1045	69
12	DIMB1245	95	5.5	11.2	.43	DIMP1245	93
14	DIMB1445	170	5.0	13.0	.51	DIMP1445	146
16	DIMB1645	214	5.5	13.5	.52	DIMP1645	184
18	DIMB1845	253	6.0	14.0	.54	DIMP1845	246
20	DIMB2045	310	7.0	15.0	.57	DIMP2045	293
24	DIMB2445	410	7.5	15.5	.61	DIMP2445	390
30	DIMB3045	716	10.5		.66		
36	DIMB3645	1110	11.5		.76		
42	DIMB4245	1610	14.0		.82		
48	DIMB4845	2090	15.0		.90		

Weights in Pounds
Dimensions in Inches
All Weights shown without accessories

KINGER

MECHANICAL JOINT COMPACT FITTINGS

DUCTILE IRON CLASS 350 as per ANSI / AWWA C153 / A21.53

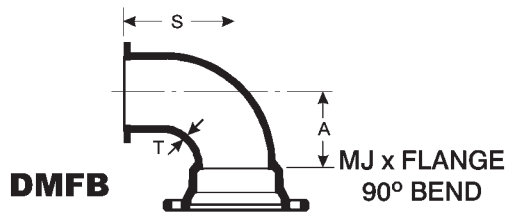

DMFB

MJ x FLANGE
90° BEND

90° BENDS: MJ x FLANGE

Size	Item No.	A	S	T	Wt.
3	DMFB390	4.0	5.5	.34	21
4	DMFB490	4.7	6.5	.35	28
6	DMFB690	6.2	8.0	.37	46
8	DMFB890	7.2	9.0	.39	71
10	DMFB1090	9.2	11.0	.41	121
12	DMFB1290	10.2	12.0	.43	155
16	DMFB1690	12.5	15.0	.52	280
20	DMFB2090	15.5	18.0	.57	441
24	DMFB2490	18.5	22.0	.61	618

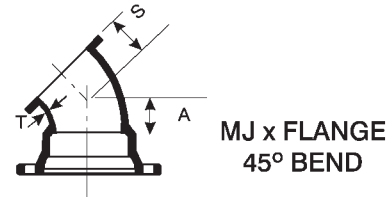

DMFB

MJ x FLANGE
45° BEND

45° BENDS: MJ x FLANGE

Size	Item No.	A	S	T	Wt.
3	DMFB345	1.5	3.0	.34	17
4	DMFB445	2.2	4.0	.35	34
6	DMFB645	3.2	5.0	.37	57
8	DMFB845	3.7	5.5	.39	83
10	DMFB1045	4.7	6.5	.41	122
12	DMFB1245	5.7	7.5	.43	159
16	DMFB1645	5.5	8.0	.52	290
20	DMFB2045	6.0	9.5	.57	338
24	DMFB2490	7.0	11.0	.61	442

ADAPTERS: MJ x FLANGE

Size	Item No.	L	T	Wt.
3	DMFA3	3.5	.34	18
4	DMFA4	3.5	.35	24
6	DMFA6	3.5	.37	36
8	DMFA8	3.5	.39	52
10	DMFA10	3.5	.41	67
12	DMFA12	3.5	.43	80
14	DMFA14	5.0	.51	126
16	DMFA16	5.0	.52	166
18	DMFA18	5.0	.54	206
20	DMFA20	5.0	.57	275
24	DMFA24	5.0	.61	324
30	DMFA30	7.0	.66	420

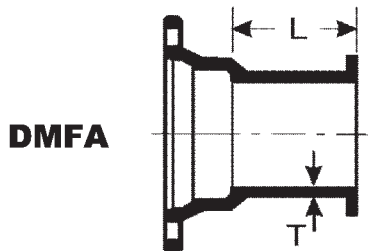

DMFA

CROSSES

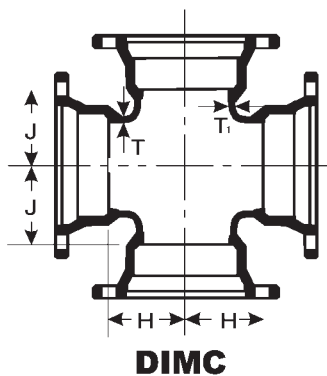

DIMC

Size		Item No.	H	J	T	T ₁	Wt.
Run	Branch						
3	3	DIMC33	3.0	3.0	.34	.34	35
4	3	DIMC43	3.0	4.0	.35	.34	49
4	4	DIMC44	4.0	4.0	.35	.35	40
6	4	DIMC64	4.0	5.0	.37	.35	68
6	6	DIMC66	5.0	5.0	.37	.37	75
8	4	DIMC84	4.0	6.0	.39	.35	99
8	6	DIMC86	5.0	6.0	.39	.37	108
8	8	DIMC88	6.0	6.0	.39	.39	105
10	3	DIMC103	3.0	7.0	.41	.34	115
10	4	DIMC104	4.0	7.0	.41	.35	98
10	6	DIMC106	5.0	7.0	.41	.37	118
10	8	DIMC108	6.0	7.0	.41	.39	138
10	10	DIMC1010	7.0	7.0	.41	.41	145
12	4	DIMC124	4.0	8.5	.43	.35	100
12	6	DIMC126	5.0	8.5	.43	.37	140
12	8	DIMC128	6.0	8.5	.43	.39	162
12	10	DIMC1210	7.0	8.5	.43	.41	190
12	12	DIMC1212	8.5	8.5	.43	.43	213
14	8	DIMC148	8.0	10.5	.51	.39	259
14	14	DIMC1414	10.5	10.5	.51	.51	299
16	6	DIMC166	7.0	12.0	.52	.37	250
16	8	DIMC168	8.0	12.0	.52	.39	289
16	10	DIMC1610	9.0	12.0	.52	.41	345
16	12	DIMC1612	10.0	12.0	.52	.43	397
16	16	DIMC1616	11.5	11.5	.52	.52	385
20	20	DIMC2020	14.0	14.0	.57	.57	605
24	24	DIMC2424	16.0	16.0	.61	.61	830

Weights in Pounds
Dimensions in Inches
All Weights shown without accessories

KINGER

MECHANICAL JOINT COMPACT FITTINGS

DUCTILE IRON CLASS 350 as per ANSI / AWWA C153 / A21.53

TEES

Size	MJ x MJ				T		MJ x FLANGE			
	Item No.	Wt.	H	J			Item No.	Wt.	H	L
2 x 2	DIMT22	16	3.00	3.00	.30	.30				
3 x 3	DIMT33	28	3.00	3.00	.34	.34	DIMF33	28	N/A	N/A
4 x 2	DIMT42	29	3.00	4.00	.35	.30				
4 x 3	DIMT43	30	3.50	4.00	.35	.34	DIMF43	34	N/A	N/A
4 x 4	DIMT44	32	4.00	4.00	.35	.35	DIMF44	38	4.00	6.5
6 x 3	DIMT63	42	3.50	5.00	.37	.34	DIMF63	51	4.00	8.0
6 x 4	DIMT64	46	4.00	5.00	.37	.35	DIMF64	54	5.00	8.0
6 x 6	DIMT66	56	5.00	5.00	.37	.37	DIMF66	56	5.00	8.0
8 x 3	DIMT83	52	N/A	N/A	N/A	N/A	DIMF83	70	4.00	9.0
8 x 4	DIMT84	60	4.00	6.50	.39	.35	DIMF84	72	5.00	9.0
8 x 6	DIMT86	72	5.00	6.50	.39	.37	DIMF86	83	5.00	9.0
8 x 8	DIMT88	86	6.50	6.50	.39	.39	DIMF88	94	6.50	9.0
10 x 3	DIMT103	75	4.00	7.50	.41	.34	DIMF103	90		
10 x 4	DIMT104	78	4.00	7.50	.41	.35	DIMF104	89	5.00	11.0
10 x 6	DIMT106	90	5.00	7.50	.41	.37	DIMF106	107	5.00	11.0
10 x 8	DIMT108	105	6.50	7.50	.41	.39	DIMF108	115	6.50	11.0
10 x 10	DIMT1010	120	7.50	7.50	.41	.41	DIMF1010	130	7.50	11.0
12 x 3	DIMT123	90	4.00	8.75	.43	.34				
12 x 4	DIMT124	94	4.00	8.75	.43	.35	DIMF124	115	5.00	12.0
12 x 6	DIMT126	110	5.00	8.75	.43	.37	DIMF126	120	5.00	12.0
12 x 8	DIMT128	125	6.50	8.75	.43	.39	DIMF128	146	6.50	12.0
12 x 10	DIMT1210	140	7.50	8.75	.43	.41	DIMF1210	174	7.50	12.0
12 x 12	DIMT1212	160	8.75	8.75	.43	.43	DIMF1212	198	8.75	12.0
14 x 6	DIMT146	182	6.50	10.50	.51	.37				
14 x 8	DIMT148	206	7.50	10.50	.51	.39				
14 x 10	DIMT1410	228	8.50	10.50	.51	.41				
14 x 12	DIMT1412	234	9.50	10.50	.51	.43				
14 x 14	DIMT1414	280	10.50	10.50	.51	.51				
16 x 6	DIMT166	228	6.50	11.50	.52	.37	DIMF166	213	6.00	15.0
16 x 8	DIMT168	248	7.50	11.50	.52	.39	DIMF168	260	8.00	15.0
16 x 10	DIMT1610	264	8.50	11.50	.52	.41	DIMF1610	287	9.00	15.0
16 x 12	DIMT1612	280	9.50	11.50	.52	.43	DIMF1612	312	10.00	15.0
16 x 14	DIMT1614	316	10.50	11.50	.52	.51				
16 x 16	DIMT1616	322	11.50	11.50	.52	.52				
18 x 6	DIMT186	275	6.50	12.50	.54	.37	DIMF186	261	7.00	15.5
18 x 8	DIMT188	295	7.50	12.50	.54	.39				
18 x 18	DIMT1818	435	12.50	12.50	.54	.54				
20 x 6	DIMT206	315	6.50	14.00	.57	.37	DIMF206	345	7.00	17.0
20 x 8	DIMT208	345	8.00	14.00	.57	.39	DIMF208	384	8.00	17.0
20 x 10	DIMT2010	370	9.00	14.00	.57	.41				
20 x 12	DIMT2012	395	10.00	14.00	.57	.43				
20 x 16	DIMT2016	465	12.00	14.00	.57	.52				
20 x 18	DIMT2018	505	13.00	14.00	.57	.54				
20 x 20	DIMT2020	535	14.00	14.00	.57	.57				
24 x 6	DIMT246	415	7.00	16.00	.61	.37	DIMF246	460	7.00	19.0
24 x 8	DIMT248	445	8.00	16.00	.61	.39	DIMF248	418	8.50	19.0
24 x 10	DIMT2410	470	9.00	16.00	.61	.41				
24 x 12	DIMT2412	500	10.00	16.00	.61	.43				
24 x 16	DIMT2416	580	12.00	16.00	.61	.52				
24 x 18	DIMT2418	625	13.00	16.00	.61	.54				
24 x 20	DIMT2420	660	14.00	16.00	.61	.57				
24 x 24	DIMT2424	720	16.00	16.00	.61	.61				
30 x 6	DIMT306	700	7.00	20.00	.66	.37				
30 x 12	DIMT3012	739	10.00	20.00	.66	.43				
30 x 16	DIMT3016	959	12.50	20.00	.66	.52				
30 x 24	DIMT3024	1160	16.00	20.00	.66	.61				
30 x 30	DIMT3030	1323	20.00	20.00	.66	.66				
36 x 12	DIMT3612	1205	10.00	23.50	.76	.43				
36 x 16	DIMT3616	1350	12.50	23.50	.76	.52				
36 x 24	DIMT3624	1498	16.00	23.50	.76	.61				
36 x 36	DIMT3636	1900	23.50	23.50	.76	.76				
42 x 24	DIMT4224	2270	20.00	29.50	.82	.61				
42 x 30	DIMT4230	2425	22.00	29.50	.82	.66				
42 x 36	DIMT4236	3000	30.00	30.00	.82	.74				
42 x 42	DIMT4242	3175	30.00	30.00	.82	.82				
48 x 24	DIMT4824	2870	23.00	32.00	.90	.61				
48 x 30	DIMT4830	3050	23.00	32.00	.90	.66				
48 x 36	DIMT4836	3900	33.50	33.25	.90	.74				
48 x 42	DIMT4842	4100	33.50	33.50	.90	.82				
48 x 48	DIMT4848	4250	33.50	33.50	.90	.90				

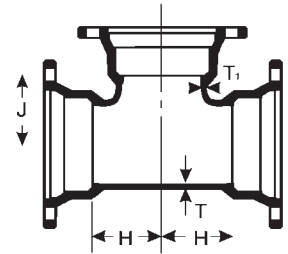

**MJ x MJ
DIMT**

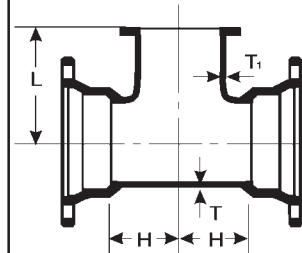

**MJ x FLANGE
DIMF**

Weights in Pounds
Dimensions in Inches
All Weights shown without accessories

KINGER

MECHANICAL JOINT COMPACT FITTINGS

DUCTILE IRON CLASS 350 as per ANSI / AWWA C153 / A21.53

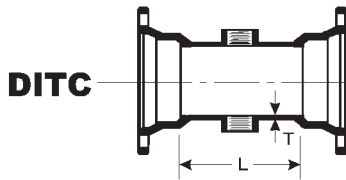
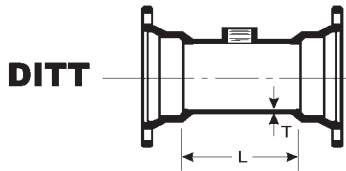

TAPPED TEES AND TAPPED CROSSES

Size	TEE		CROSS		T	L	Tap Size
	Item No.	Wt.	Item No.	Wt.			
3	DITT3	19	DITC3	19	.34	6	2
4	DITT4	23	DITC4	23	.35	6	2
6	DITT6	37	DITC6	37	.37	6	2
8	DITT8	53	DITC8	53	.39	6	2
10	DITT10	68	DITC10	68	.41	6	2
12	DITT12	88	DITC12	88	.43	6	2
16	DITT16	164	DITC16	202	.52	8	2
20	DITT20	259	DITC20	259	.57	10	2
24	DITT24	320	DITC24	320	.61	10	2

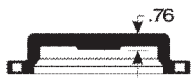

DIMC



DITC



DIMP

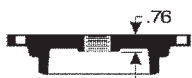

DITP

CAPS AND PLUGS

Size	SOLID CAP	TAPPED CAP	Wt.	SOLID PLUG	TAPPED PLUG	Wt.
	Item No.	Item No.		Item No.	Item No.	
2	DIMC2		10			
3	DIMC3	DITC3	8	DIMP3	DITP3	8
4	DIMC4	DITC4	9	DIMP4	DITP4	10
6	DIMC6	DITC6	15	DIMP6	DITP6	16
8	DIMC8	DITC8	22	DIMP8	DITP8	26
10	DIMC10	DITC10	32	DIMP10	DITP10	36
12	DIMC12	DITC12	42	DIMP12	DITP12	46
14	DIMC14	DITC14	66	DIMP14	DITP14	75
16	DIMC16	DITC16	92	DIMP16	DITP16	95
18	DIMC18	DITC18	114	DIMP18	DITP18	121
20	DIMC20	DITC20	125	DIMP20	DITP20	135
24	DIMC24	DITC24	166	DIMP24	DITP24	175
30	DIMC30	DITC30	345	DIMP30	DITP30	355

DIPP

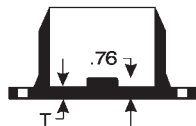

DPTP

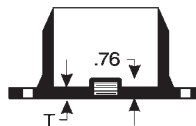

PUSH-IN PLUGS

Size	SOLID PLUG Item No.	TAPPED PLUG Item No.	Wt.	T
4	DIPP4	DP4P4	12	.43
6	DIPP6	DP4P6	20	.47
8	DIPP8	DP4P8	27	.49
10	DIPP10	DP4P10	36	.52
12	DIPP12	DP4P12	47	.54
16	DIPP16	DP4P16	59	.60

45° LATERALS

Size		Item No.	X	Y	T	T ₁	Wt.
Run	Branch						
3	3	DIMY33	2.0	8.5	.34	.34	36
4	4	DIMY44	2.5	9.5	.35	.35	45
6	4	DIMY64	1.5	11.0	.37	.35	67
6	6	DIMY66	3.0	13.0	.37	.37	93
8	4	DIMY84	0.5	13.0	.39	.35	93
8	6	DIMY86	2.0	14.5	.39	.37	113
8	8	DIMY88	3.5	16.0	.39	.39	136
10	4	DIMY104	0.0	15.0	.41	.35	118
10	6	DIMY106	1.0	16.0	.41	.37	136
10	8	DIMY108	2.5	17.0	.41	.39	170
10	10	DIMY1010	3.5	19.0	.41	.41	199
12	4	DIMY124	0.0	16.5	.43	.35	150
12	6	DIMY126	1.5	18.5	.43	.37	186
12	8	DIMY128	1.5	18.5	.43	.39	188
12	10	DIMY1210	3.0	20.0	.43	.41	223
12	12	DIMY1212	4.5	22.5	.43	.43	272

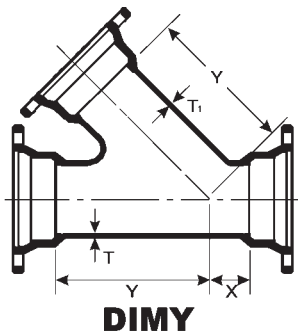

DIMY

Weights in Pounds
Dimensions in Inches
All Weights shown without accessories

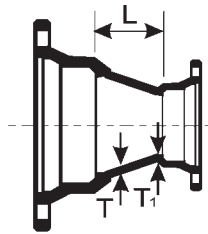

DIMR

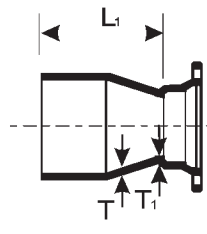

DSPR

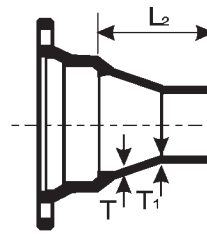

DLPR

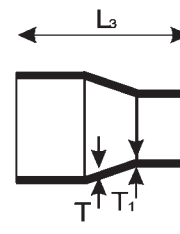

DPPR

REDUCERS

Size	MJ x MJ			PE x MJ (Small End MJ)			MJ x PE (Large End MJ)			PE x PE			T	T ₁
	Item No.	Wt.	L	Item No.	Wt.	L ₁	Item No.	Wt.	L ₂	Item No.	Wt.	L ₃		
4 x 2	DIMR42	16	2.5	DSPR42	14	8.0							.35	.30
4 x 3	DIMR43	18	3.0	DSPR43	17	8.5	DLPR43	18	8.5	DPPR43	17	14.0	.35	.34
6 x 3	DIMR63	22	5.0	DSPR63	23	10.5	DLPR63	26	10.5	DPPR63	25	16.0	.37	.34
6 x 4	DIMR64	24	4.0	DSPR64	26	9.5	DLPR64	28	9.5	DPPR64	25	15.0	.37	.35
8 x 4	DIMR84	32	5.0	DSPR84	33	10.5	DLPR84	34	10.5	DPPR84	33	16.0	.39	.35
8 x 6	DIMR86	36	4.0	DSPR86	36	9.5	DLPR86	37	9.5	DPPR86	35	15.0	.39	.37
10 x 4	DIMR104	46	7.0	DSPR104	44	12.5	DLPR104	44	12.5	DPPR104	47	18.0	.41	.35
10 x 6	DIMR106	47	5.0	DSPR106	46	10.5	DLPR106	46	10.5	DPPR106	46	16.0	.41	.37
10 x 8	DIMR108	50	4.0	DSPR108	49	9.5	DLPR108	50	9.5	DPPR108	50	15.0	.41	.39
12 x 4	DIMR124	58	9.0	DSPR124	60	14.5	DLPR124	61	14.5	DPPR124	59	20.0	.43	.35
12 x 6	DIMR126	58	7.0	DSPR126	60	12.5	DLPR126	60	12.5	DPPR126	60	18.0	.43	.37
12 x 8	DIMR128	57	5.0	DSPR128	61	10.5	DLPR128	62	10.5	DPPR128	60	16.0	.43	.39
12 x 10	DIMR1210	61	4.0	DSPR1210	61	9.5	DLPR1210	64	9.5	DPPR1210	65	15.0	.43	.41
14 x 6	DIMR146	100	9.0										.51	.37
14 x 8	DIMR148	100	7.0										.51	.39
14 x 10	DIMR1410	100	5.0										.51	.41
14 x 12	DIMR1412	100	4.0										.51	.43
16 x 6	DIMR166	124	11.0	DSPR166	139	20.0	DLPR166	158	21.0	DPPR166	133	29.0	.52	.37
16 x 8	DIMR168	124	9.0	DSPR168	134	18.0	DLPR168	158	18.0	DPPR168	133	26.0	.52	.39
16 x 10	DIMR1610	124	7.0	DSPR1610	132	16.0	DLPR1610	151	16.0	DPPR1610	129	22.0	.52	.41
16 x 12	DIMR1612	112	5.0	DSPR1612	124	14.0	DLPR1612	141	14.0	DPPR1612	119	20.0	.52	.43
16 x 14	DIMR1614	140	4.0				DLPR1614	135	13.0				.52	.51
18 x 6	DIMR186	194	16.0										.54	.37
18 x 8	DIMR188	190	13.0										.54	.39
18 x 12	DIMR1812	180	7.0	DSPR1812	155	16.0	DLPR1812	175	16.0	DPPR1812	150	22.0	.54	.43
18 x 14	DIMR1814	190	6.0	DSPR1814	175	15.0	DLPR1814	190	15.0	DPPR1814	160	23.0	.54	.51
18 x 16	DIMR1816	195	5.0				DLPR1816	190	13.0				.54	.52
20 x 6	DIMR206	232	22.0	DSPR206	201	30.0	DLPR206	231	27.5	DPPR206	106	35.5	.57	.37
20 x 8	DIMR208	227	19.0	DSPR208	198	27.0	DLPR208	227	24.5	DPPR208	106	32.5	.57	.39
20 x 10	DIMR2010	220	14.0	DSPR2010	200	24.0	DLPR2010	217	21.5	DPPR2010	193	29.5	.57	.41
20 x 12	DIMR2012	205	12.0	DSPR2012	186	21.0	DLPR2012	211	18.0	DPPR2012	190	26.0	.57	.43
20 x 14										DPPR2014	195	26.0	.57	.51
20 x 16	DIMR2016	200	7.0	DSPR2016	201	15.0	DLPR2016	209	15.0	DPPR2016	181	23.0	.57	.52
20 x 18	DIMR2018	225	4.0	DSPR2018	200	12.0	DLPR2018	193	12.0	DPPR2018	190	20.0	.57	.54
24 x 6	DIMR246	322	28.0	DSPR246	284	36.0	DLPR246	320	33.5	DPPR246	283	41.5	.61	.37
24 x 8	DIMR248	318	25.0	DSPR248	282	33.0	DLPR248	316	30.5	DPPR248	281	38.5	.61	.39
24 x 10	DIMR2410	312	22.0	DSPR2410	276	30.0	DLPR2410	310	27.5	DPPR2410	274	35.5	.61	.41
24 x 12	DIMR2412	305	16.0	DSPR2412	275	27.0	DLPR2412	299	24.0	DPPR2412	262	32.0	.61	.43
24 x 16	DIMR2416	320	12.0	DSPR2416	285	21.0	DLPR2416	297	21.0	DPPR2416	285	29.0	.61	.52
24 x 18	DIMR2418	305	10.0										.61	.54
24 x 20	DIMR2420	300	7.0	DSPR2420	270	15.0	DLPR2420	283	15.0	DPPR2420	240	23.0	.61	.57
30 x 24	DIMR3024	478	10.0										.66	.61
36 x 24	DIMR3624	770	19.0										.76	.61
42 x 30	DIMR4230	1356	40.0										.82	.61
42 x 36	DIMR4236	1114	15.5										.82	.74
48 x 36	DIMR4836	1641	28.0										.90	.74

Weights in Pounds
 Dimensions in Inches
 All Weights shown without accessories

KINGER

MECHANICAL JOINT COMPACT FITTINGS

DUCTILE IRON CLASS 350 as per ANSI / AWWA C153 / A21.53

DIMS

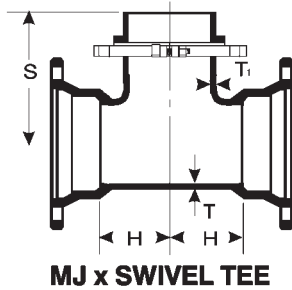

MJ x SWIVEL TEE

TEES: MJ x SWIVEL

Size	Item No.	H	S	T	T ₁	Wt.
6 x 6	DIMS66	5.0	10.0	.37	.37	77
8 x 6	DIMS86	5.0	11.0	.39	.37	89
8 x 8	DIMS88	6.5	11.0	.39	.39	116
10 x 6	DIMS106	5.0	12.5	.41	.37	113
10 x 8	DIMS108	6.5	12.5	.41	.39	129
12 x 6	DIMS126	5.0	13.5	.43	.37	128
12 x 8	DIMS128	6.5	13.5	.43	.39	149
14 x 6	DIMS146	7.0	15.0	.51	.37	211
16 x 6	DIMS166	7.0	16.0	.52	.37	248
16 x 8	DIMS168	8.0	16.0	.52	.39	298
18 x 6	DIMS186	7.0	17.0	.54	.37	300
20 x 6	DIMS206	7.0	18.5	.57	.37	358
20 x 8	DIMS208	8.0	18.5	.57	.39	382
24 x 6	DIMS246	7.0	19.0	.61	.37	458
24 x 8	DIMS248	8.5	19.0	.61	.39	477

DISG

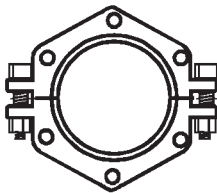

SWIVEL GLAND

Size	Item No.	Wt.
4	DISG4	8
6	DISG6	18
8	DISG8	15
10	DISG10	18
12	DISG12	24

DASS

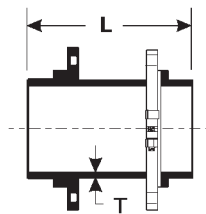

ADAPTERS: SOLID x SWIVEL

Size	Item No.	L	T	Wt.
4	DASS413	13	.35	29
6	DASS613	13	.37	47
6	DASS618	18	.37	58
6	DASS624	24	.37	69
6	DASS630	30	.37	66
6	DASS636	36	.37	75
6	DASS648	48	.37	94
6	DASS660	60	.37	112
6	DASS672	72	.37	131
8	DASS813	13	.39	52
10	DASS1013	13	.41	69
12	DASS1213	13	.43	87

DBSS

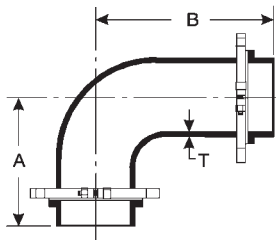

SWIVEL x SWIVEL BEND

Size	Item No.	A	B	T	Wt.
6	DBSS6	10.5	16.0	.36	52
8	DBSS8				74
10	DBSS10				102

DIRT

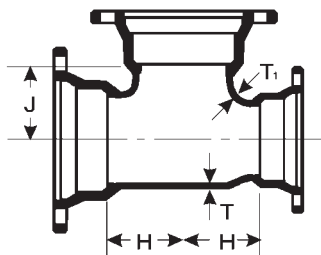

REDUCING TEES

Size	Item No.	H	J	T	T ₁	Wt.
6 x 4 x 4	DIRT644	5.0	5.00	.37	.35	43
6 x 4 x 6	DIRT646	5.0	5.00	.37	.35	57
8 x 6 x 6	DIRT866	5.0	6.50	.39	.37	73
8 x 6 x 8	DIRT868	6.0	6.50	.39	.37	82
10 x 6 x 6	DIRT1066	6.5	7.50	.41	.37	86
12 x 6 x 6	DIRT1266	7.0	8.75	.43	.37	96
12 x 6 x 8	DIRT1268	7.0	8.75	.43	.39	105

Weights in Pounds
Dimensions in Inches
All Weights shown without accessories

OFFSETS

Size	MJ x MJ		D	L	L ₁	T	MJ x PE	
	Item No.	Wt.					Item No.	Wt.
3 x 6	DMM36	30	6	9	14.5	.34	DMPE36	29
3 x 12	DMM312	40	12	15	20.5	.34	DMPE312	39
3 x 18	DMM318	49	18	21	26.5	.34	DMPE318	48
3 x 24	DMM324	55	24	27	33.5	.34	DMPE324	53
4 x 6	DMM46	45	6	10	15.5	.35	DMPE46	44
4 x 12	DMM412	55	12	16	21.5	.35	DMPE412	54
4 x 18	DMM418	65	18	22	27.5	.35	DMPE418	63
4 x 24	DMM424	75	24	28	33.5	.35	DMPE424	72
6 x 6	DMM66	41	6	12	17.5	.37	DMPE66	54
6 x 12	DMM612	65	12	18	23.5	.37	DMPE612	64
6 x 18	DMM618	75	18	24	29.5	.37	DMPE618	72
6 x 24	DMM624	85	24	30	35.5	.37	DMPE624	82
8 x 6	DMM86	84	6	13	18.5	.39	DMPE86	78
8 x 12	DMM812	90	12	19	24.5	.39	DMPE812	88
8 x 18	DMM818	100	18	25	30.5	.39	DMPE818	96
10 x 6	DMM106	105	6	15	20.5	.41	DMPE106	102
10 x 12	DMM1012	135	12	21	26.5	.41	DMPE1012	132
10 x 18	DMM1018	165	18	27	32.5	.41	DMPE1018	160
12 x 6	DMM126	124	6	17	22.5	.43	DMPE126	112
12 x 12	DMM1212	153	12	23	28.5	.43	DMPE1212	146
12 x 18	DMM1218	190	18	29	34.5	.43	DMPE1218	184
12 x 24	DMM1224	202	24	35	40.5	.43	DMPE1224	194
12 x 30	DMM1230	213	30	41	46.5	.43	DMPE1230	205

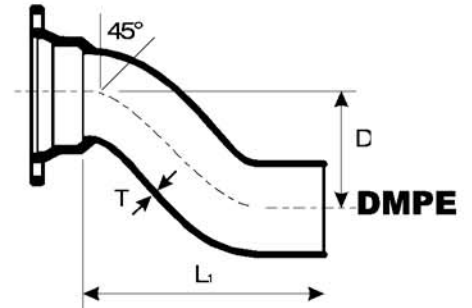
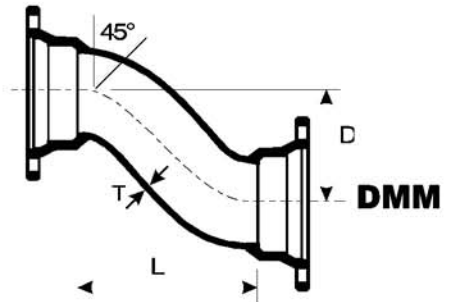

DMSS

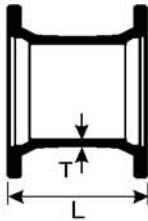

DMSL

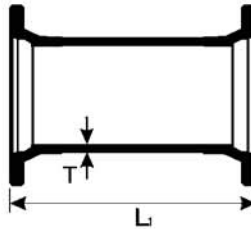

DDLS

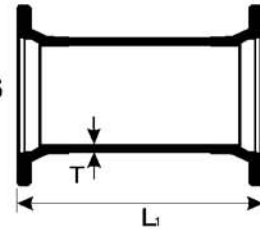

SLEEVES

Size	SHORT SLEEVE			LONG SLEEVE			T	DUAL PURPOSE SLEEVES			
	Item No.	Wt.	L	Item No.	Wt.	L ₁		Item No.	Wt.	L ₁	T
3	DMSS3	13	7.5	DMSL3	18	12	.34	DDLS3	23	12	.34
4	DMSS4	18	7.5	DMSL4	20	12	.35	DDLS4	32	12	.35
6	DMSS6	28	7.5	DMSL6	33	12	.37	DDLS6	50	12	.37
8	DMSS8	38	7.5	DMSL8	46	12	.39	DDLS8	65	12	.39
10	DMSS10	49	7.5	DMSL10	62	12	.41	DDLS10	89	12	.41
12	DMSS12	56	7.5	DMSL12	76	12	.43	DDLS12	104	12	.43
14	DMSS14	111	9.5	DMSL14	140	15	.51				
16	DMSS16	123	9.5	DMSL16	170	15	.52				
18	DMSS18	160	9.0	DMSL18	200	15	.54				
20	DMSS20	195	9.0	DMSL20	255	15	.57				
24	DMSS24	225	9.0	DMSL24	335	15	.61				
30				DMSL30	640	24	.66				
36				DMSL36	925	24	.76				
42				DMSL42	1390	24	.82				
48				DMSL48	1740	24	.90				

DUAL CUT-IN SLEEVES

Size	Item No.	Wt.	T	T ₁	A	S	L
3	DCIS3	34	.34	.36	3.96	8	20
4	DCIS4	50	.35	.37	4.80	8	20
6	DCIS6	62	.37	.39	6.90	8	20
8	DCIS8	90	.39	.41	9.05	8	20
10	DCIS10	105	.41	.43	11.10	8	20
12	DCIS12	128	.43	.45	13.20	8	20

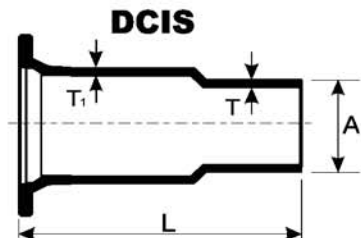

Weights in Pounds
Dimensions in Inches
All Weights shown without accessories

KINGER

ACCESSORIES

MECHANICAL JOINT COMPACT FITTINGS

DUCTILE IRON CLASS 350 as per ANSI / AWWA C153 / A21.53

DGLD

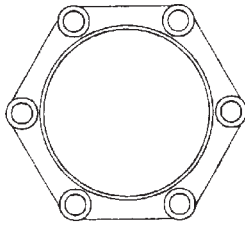

MG



TG



STANDARD GLANDS

Size	Item No.	Wt.
2	DGLD2	2
3	DGLD3	4
4	DGLD4	5
6	DGLD6	6
8	DGLD8	7
10	DGLD10	10
12	DGLD12	15
14	DGLD14	23
16	DGLD16	28
18	DGLD18	30
20	DGLD20	43
24	DGLD24	50
30	DGLD30	85
36	DGLD36	115
42	DGLD42	180
48	DGLD48	275

GASKETS

Size	STANDARD		TRANSITION	
	Item No.	Wt.	Item No.	Wt.
2	MG2			
3	MG3	.25	TG3	.50
4	MG4	.30	TG4	.60
6	MG6	.50	TG6	.75
8	MG8	.75	TG8	1.10
10	MG10	.80	TG10	1.30
12	MG12	1.00	TG12	1.65
14	MG14	1.30		
16	MG16	1.45		
18	MG18	1.60		
20	MG20	1.90		
24	MG24	2.10		
30	MG30	2.30		
36	MG36	2.75		
42	MG42	3.20		
48	MG48	3.65		

DRMG

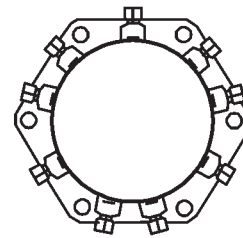

RETAINER GLANDS

Nominal Pipe Size	Item No.	Wt.	AWWA DUCTILE IRON PIPE O.D	WWP Rating (psi)	SET SCREWS		
					Qty	Size	Torque (Ft Lbs)
3	DRMG3	5	3.96	350	4	5/8 X 2	85
4	DRMG4	7	4.80	350	4	5/8 X 2	85
6	DRMG6	12	6.90	350	6	5/8 X 2	85
8	DRMG8	16	9.05	250	9	5/8 X 2	85
10	DRMG10	22	11.10	250	16	5/8 X 2	85
12	DRMG12	28	13.20	250	16	5/8 X 2	85
14	DRMG14	45	15.30	250	20	5/8 X 2	85
16	DRMG16	52	17.40	250	24	5/8 X 2	85
18	DRMG18	62	19.50	200	24	5/8 X 2	85
20	DRMG20	75	21.60	200	28	3/4 X 2-1/2	110
24	DRMG24	97	25.80	200	32	3/4 X 2-1/2	110
30	DRMG30	196	32.00	100	40	3/4 X 2-1/2	110
36	DRMG36	246	38.30	100	48	3/4 X 2-1/2	110
42	DRMG42	302	44.50	100	56	3/4 X 2-1/2	110
48	DRMG48	380	50.80	100	64	3/4 X 2-1/2	110

Weights in Pounds
Dimensions in Inches
All Weights shown without accessories

KINGER

PACKAGED ACCESSORIES

MECHANICAL JOINT COMPACT FITTINGS
 DUCTILE IRON CLASS 350 as per ANSI / AWWA C153 / A21.53

Gland Pack - includes Gland, MJ Gasket and Std. T-Head Bolts

Size in.	Item No.	Wt. lb.
2	DGGB2	6
3	DGGB3	7
4	DGGB4	8
6	DGGB6	12
8	DGGB8	15
10	DGGB10	20
12	DGGB12	25
14	DGGB14	37
16	DGGB16	43
18	DGGB18	47
20	DGGB20	61
24	DGGB24	72

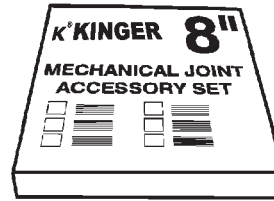

Transition Gland Pack - includes Gland, Transition Gasket and Std. T-Head Bolts

Size in.	Item No.	Wt. lb.
3	DGTB3	7
4	DGTB4	8
6	DGTB6	12
8	DGTB8	15
10	DGTB10	20
12	DGTB12	25

Retainer Gland Pack - includes Gland, MJ Gasket and Std. T-Head Bolts

Size in.	Item No.	Wt. lb.
3	DRGT3	9
4	DRGT4	10
6	DRGT6	15
8	DRGT8	19
10	DRGT10	25
12	DRGT12	32

Bolt Pack - Gasket & Bolts, without Gland

Size in.	Item No.	Wt. lb.
3	DIGB3	3
4	DIGB4	4
6	DIGB6	6
8	DIGB8	7
10	DIGB10	8
12	DIGB12	9

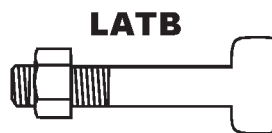

LOW ALLOY, CORROSION RESISTANT, STEEL T-HEAD BOLTS

Standard Bolts		
Size in.	Item No.	Wt.
5/8 x 3	LATB30	.50
3/4 x 3 1/2	LATB35	.75
3/4 x 4	LATB40	.85
3/4 x 4 1/2	LATB45	1.00
3/4 x 5	LATB50	1.25
1 x 6	LATB60	2.25
1 1/4 x 6	LATB61	2.50

Anti-Rotation Bolts		
Size in.	Item No.	Wt. lb.
3/4 x 3 1/2	DATB35	.75
3/4 x 4	DATB40	1.00
3/4 x 4 1/2	DATB45	1.25
3/4 x 5	DATB50	1.50

Weights in Pounds
 Dimensions in Inches
 All Weights shown without accessories