

AWWA C508 Flanged Resilient-Seated Swing Check Valve With Weight & Lever (JKHCV-F250-3)

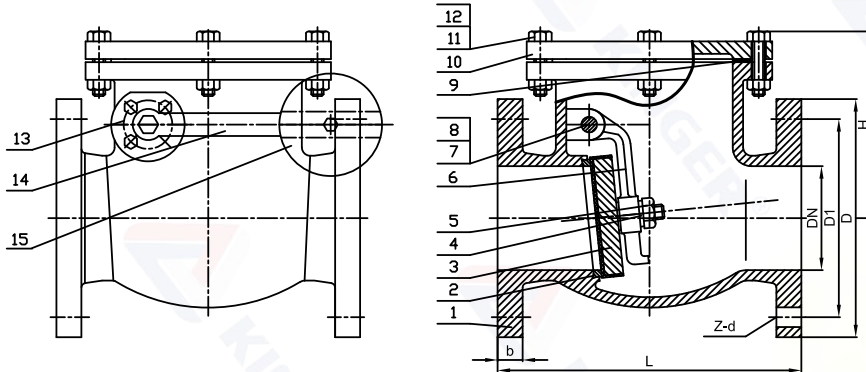

MATERIAL SPECIFICATION

Part No.	Description	Material Specification	
1	Body	Ductile Iron ASTM A536	
2	Body Seat Ring	Brass ASTM B16	
3	Disc	DI ASTM A536+EPDM ASTM D2000	
4	Washer	Stainless Steel SS316	
5	Nut	Stainless Steel SS316	
6	Arm	Ductile Iron ASTM A536	
7	Hing Pin	Stainless Steel SS420	
8	O-Ring	EPDM ASTM D2000	
9	Gasket	EPDM ASTM D2000	
10	Bonnet	Ductile Iron ASTM A536	
11	Bolt	Stainless Steel SS316	
12	Nut	Stainless Steel SS316	Size:1.5-6" N/A
			Size:8-36" A
13	Gland	Brass ASTM B16	Size:1.5-4"
		Ductile Iron ASTM A536	Size:5-36"
14	Hinge	Ductile Iron ASTM A536	
15	Hammer	Ductile Iron ASTM A536	



- Design Basis: AWWA C508
- Connection Ends: Flange to ASME B16.1 CL 125/ASME B16.42 CL150
- Working Pressure: 250PSI available upon request
- Temperature Range: 32 -176
- Coating: Fusion Bonded Epoxy Coating in accordance with ANSI/AWWA C550

Note:For special material request other than standard specification,please indicate clearly on the inquiry or order list.

Item No.	Dimensions (Inch)							
	Size	D	D1	b	z	d	L	H
JKHCV-F250015	1.5"	5.00	3.88	0.56	4	0.625	6.50	4.72
JKHCV-F25002	2"	6.00	4.75	0.62	4	0.750	8.00	5.39
JKHCV-F250025	2.5"	7.00	5.50	0.69	4	0.750	8.50	5.63
JKHCV-F25003	3"	7.50	6.00	0.75	4	0.750	9.50	6.06
JKHCV-F25004	4"	9.00	7.50	0.94	8	0.750	11.50	6.73
JKHCV-F25005	5"	10.00	8.50	0.94	8	0.875	13.00	8.03
JKHCV-F25006	6"	11.00	9.50	1.00	8	0.875	14.00	8.62
JKHCV-F25008	8"	13.50	11.75	1.12	8	0.875	19.50	10.16
JKHCV-F25010	10"	16.00	14.25	1.19	12	1.000	24.50	11.42
JKHCV-F25012	12"	19.00	17.00	1.25	12	1.000	27.50	12.80
JKHCV-F25014	14"	21.00	18.75	1.38	12	1.125	31.00	14.21
JKHCV-F25016	16"	23.50	21.25	1.44	16	1.125	36.00	15.28
JKHCV-F25018	18"	25.00	22.75	1.56	16	1.250	40.00	17.72
JKHCV-F25020	20"	27.50	25.00	1.69	20	1.250	40.00	20.39
JKHCV-F25024	24"	32.00	29.50	1.88	20	1.375	48.00	24.41
JKHCV-F25030	30"	38.75	36.00	2.12	28	1.375	56.00	30.04
JKHCV-F25036	36"	46.00	42.75	2.38	32	1.625	77.00	37.80